

x1

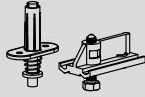

x2



x2

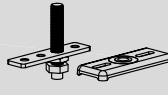

x2



x6



25KG  
55lb

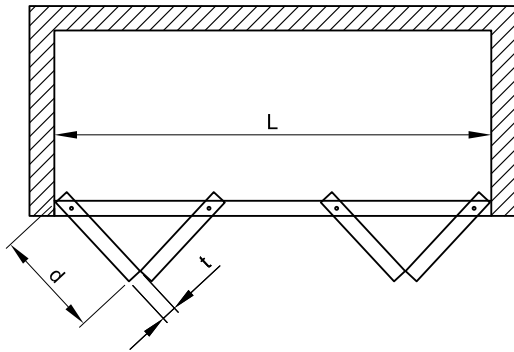

$$d = (L - 2x - 8) / 4$$

$$[d = (L - 2x - 5/16) / 4]$$

t [mm]	<22	22	25	28	32	40
x [mm]	0	3	4	4	6	6
t [in]	<7/8	7/8	1	1 1/8	1 1/4	1 1/4
x [in]	0	1/8	1/8	3/16	3/16	3/16

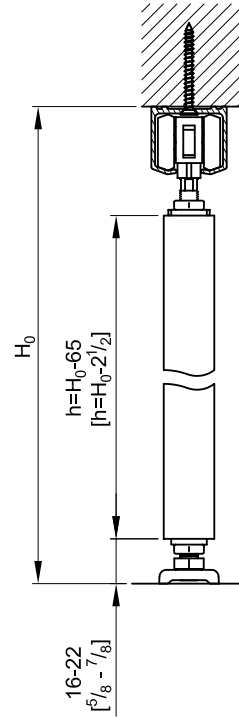

**1**

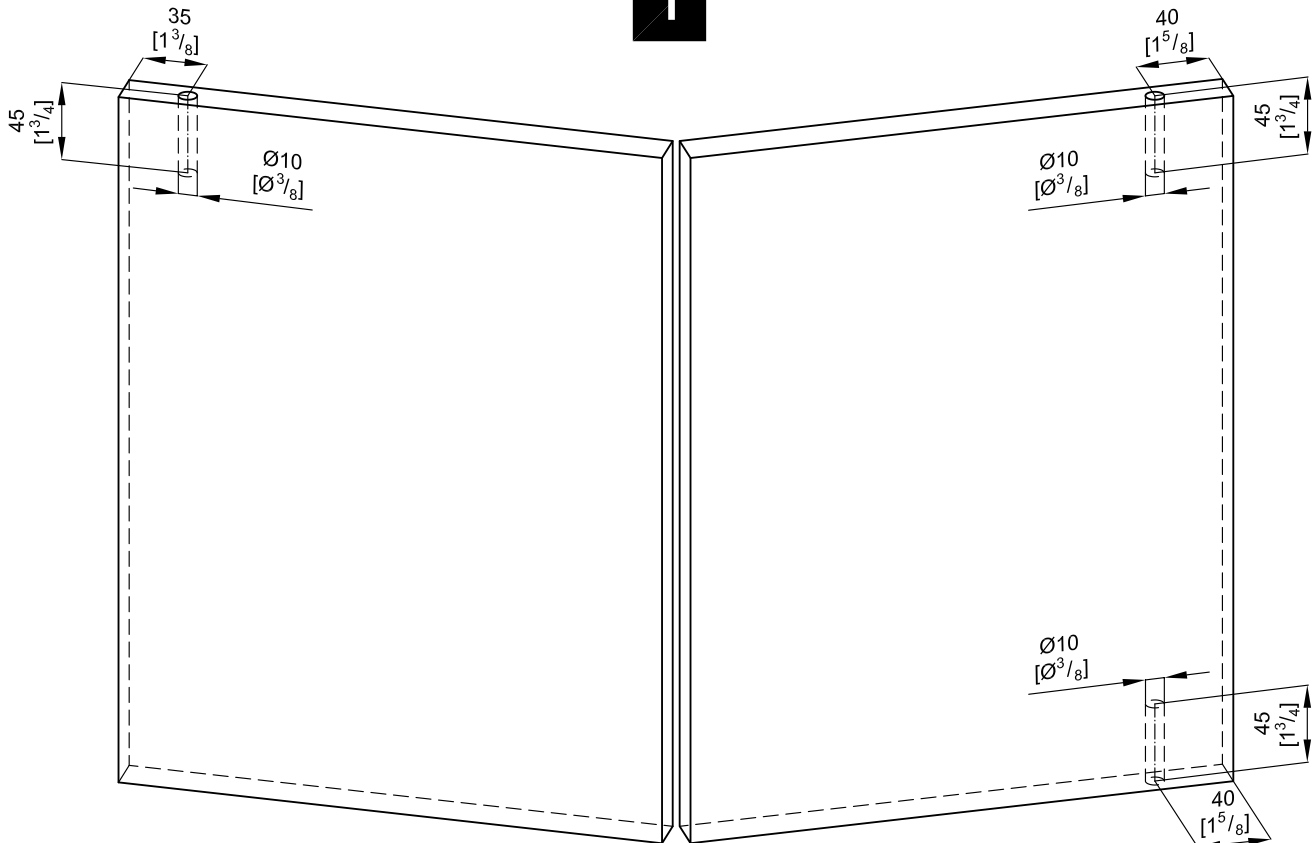

2

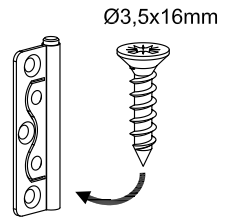
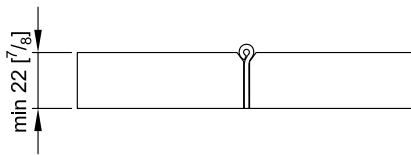
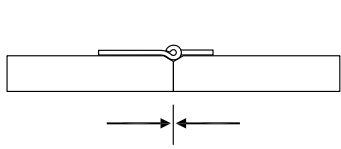

3

